

EN

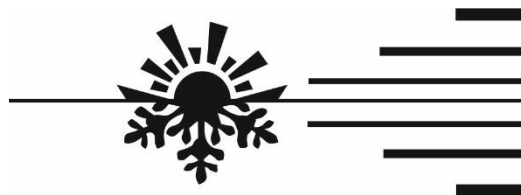

Operation manual

Air heater

PLANAR-2D

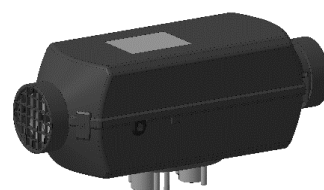

PLANAR-4DM2-12/24-P

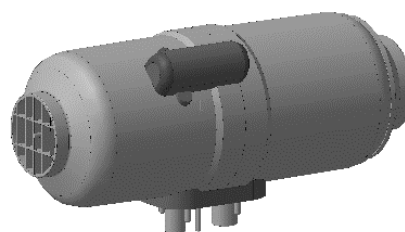

PLANAR-44D-12/24-GP-P

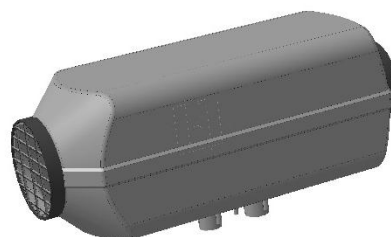

PLANAR-8DM-12/24-P

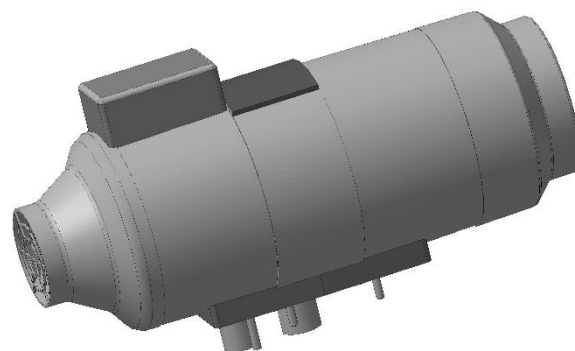

Dear Customer!

Thank you for choosing this heater! We have done everything possible to make this product meet your requirements, while its quality satisfies the best world standards.

Introduction

The PLANAR heaters are designed to be used:

- to keep the operator cabin warm;
- to provide heating for various limited volume interior spaces in vehicles;
- to maintain comfortable room temperatures for a long time.

The heater operates independently of the vehicle engine. The principle of operation is based on forcing heated air through the heat exchanger system of the heater.

Please read these instructions carefully to learn about all the functions of the heater.

Техника безопасности

Installation of the heater and its component parts must be carried out by specialized organizations approved by the manufacturer. Installation of the heater must be carried out only by specialists in accordance with the installation instructions.



Health hazard

- The heater may only be used for the purposes specified in this manual.
- Due to the risk of poisoning by exhaust fumes when the heater is operating, the heater shall NOT be used in vehicles located in closed and poorly ventilated premises (garages, shops, etc.).



Danger of property damage

When refuelling the car, the heater shall be switched off.

- The heater power shall not be disconnected until the end of the purge cycle.
- Any electrical connections or disconnections of the heater shall NOT be carried out while the power is ON.
- Do not step or put any items on the heater.
- Do not put any garments, pieces of fabric, etc., on the heater, nor place them in front of the intake or output of heated air.
- After turning off the heater, reconnection should be made at least after 5-10 seconds.
- For safe operation of the heater, the customer service should be contacted to identify and repair malfunction after two consecutive failed start-ups.

Heater Controls

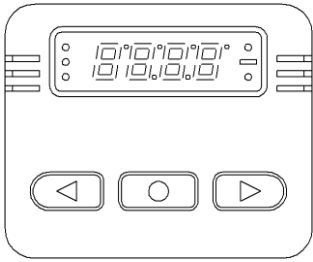

Controller PU-16M

- Starting the heater for an unlimited time.
 - Selection of Power Control/Temperature Control.
 - Setting of Ventilation mode.
 - Indication of temperature settings.
 - Temperature indication.
 - Indication of a selected temperature sensor.
-

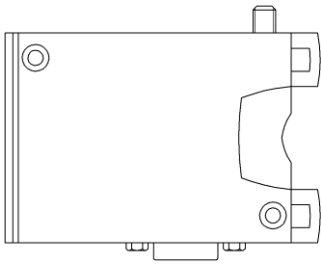

GSM-modem

- Start-up and Shutdown of the heater.
 - Setting of operation time.
 - Power Control/Temperature Control.
 - Setting of ventilation mode.
 - Temperature indication.
 - Indication of a selected temperature sensor
-

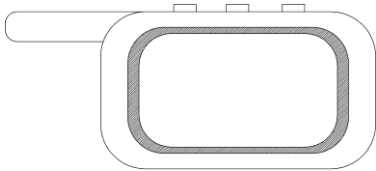

Remote Control

- Starting the heater for 2 hours.
- Heater operation at max. Power Control mode

Kit

The standard kit contains:

- Controller PU-16M;
- Fuel Pump;
- Fuel Tank, Fuel Intake, T-fitting;
- Harnesses;
- Air Intake;
- Exhaust hose;

In addition to standard equipment, you can purchase and install a cab sensor and a GSM modem.

Responsibility



Failure to follow these instructions and the requirements contained therein results in the exclusion of any liability on the part of the manufacturer. The same applies to the repair specialist who does not have the necessary qualifications, or uses non-original parts without obtaining a permission of the manufacturer.

If you have any problems, we strongly recommend that you contact authorized service centers, addresses and telephone numbers of which you can find out from the company, the seller or on the website www.autoterm.ru.

Automatic Control Features

- 1) if for some reason the heater did not start, the start-up process will be automatically repeated. After two failed attempts the heater will be switched off;
- 2) if during the heater's operation burning is interrupted, the heater automatically re-starts. Restarts after consecutive flameouts are performed up to three times;
- 3) in case of overheating of the heater coil (for example, due to blocked intake or output of the heating unit), the heater is automatically switched off;
- 4) if the maximum temperature of the heated air is exceeded (for example, due to closed outlet of the heating unit), the heater is automatically switched off;
- 5) if voltage drops below 20V (10V) or increases to more than 30V (16V), the heater automatically switches off. The numbers in parentheses are for the heaters with the nominal voltage of 12V;
- 6) in case of emergency shutdown, the appropriate fault code is displayed on the Controller display and a LED starts flashing;
- 7) *if any of the temperature sensors is faulty, the heater does not start and displays a fault code 32 or 11;

* - only for the heaters of the *PLANAR-8D* type.

Maintenance

It is recommended to send the heater for regular maintenance and testing to specialized service centers.

Many types of repairs and maintenance works on the heater require professional knowledge and special tools. Improper maintenance can result in damage to the heater.



We recommend to independently conduct the following services:

- For optimum performance, the heater should be taken to a specialized service center for inspection and maintenance at least once a year.
- If the heater is not in use, it is necessary to operate it once a month for 5-10 minutes, including the warm season, to ensure reliable operation of the heater .
- Regularly check the battery charge.
- Before the start of the heating season, check the fuel tank. If the tank stored fuel for a long time (for example from the past heating season), it is necessary to drain it! Rinse the tank with gasoline or kerosene and fill it with fresh diesel fuel. This procedure is designed to remove sediment formed in the fuel during prolonged storage. Failure to follow this procedure can lead to clogging or failure of the fuel pump and increased sooting in the combustion chamber.
- In case of a long parking or storing the vehicle, disconnect the heater from the power source (battery) to prevent it from discharging (current consumption of the heater out of service is $(30 \div 40)$ mA).
- Reliable operation of the heater depends on the grade of fuel used. Fuel grade is selected depending on ambient temperature.

Malfunctions

Actions in the event of a malfunction.

- check for the presence of fuel in the tank and the fuel line downstream of the fuel pump;
- check the 25A fuses;
- check for loose connections in connectors and fuse holders (possible oxidation of contacts);
- disconnect the power connector for 1-2 minutes and re-connect it again.

All other problems can be identified by the fault code, which is displayed on the Controller.

Attention! If, during start-up and operation of the heater the error message "Overheating" is repeated 3 times in a row, the heater will be locked. Locking is made upon actual overheating, regardless of input from the sensors that produced errors. In case of locking, the controller display will show code 33. To unlock the heater you need to contact a service center.

We recommend not to wait for the lock of the heater, and immediately after the first overheating start troubleshooting causes of failure.

Check intake and output of the heating unit for free passage of heated air.

Technical Data and Specifications

Characteristics	Models			
	PLANAR-8DM-12-P		PLANAR-8DM-24-P	
Rated voltage, V	12		24	
Fuel	diesel fuel, depending on the ambient temperature			
Heating output, kW:	max	min	max	min
	6	3,2	7,5	3,2
Hot air flow, m ³ /h:	max	min	max	min
	175	70	235	70
Fuel consumption, l/h:	max	min	max	min
	0,76	0,42	0,9	0,42
Power consumption, W:	max	min	max	min
	75	8	90	9
Start-up and Shutdown	manual			
Mass, kg, max	12			

Characteristics	Models			
	PLANAR-44D-12-GP-P		PLANAR-44D-24-GP-P	
Rated voltage, V	12		24	
Fuel	diesel fuel, depending on the ambient temperature			
Heating output, kW:	max	min	max	min
	4	1	4	1
Hot air flow, m ³ /h:	max	min	max	min
	120	70	120	70
Fuel consumption, l/h:	max	min	max	min
	0,514	0,12	0,514	0,12
Power consumption, W:	max	min	max	min
	57	10	56	10
Start-up and Shutdown	manual			
Mass, kg, max	10			

Technical Data and Specifications

Characteristics	Models			
	PLANAR-2D-12		PLANAR-2D-24	
Rated voltage, V	12		24	
Fuel	diesel fuel, depending on the ambient temperature			
Heating output, kW:	max	min	max	min
	2	0,8	8	0,8
Hot air flow, m ³ /h:	max	min	max	min
	75	34	75	34
Fuel consumption, l/h:	max	min	max	min
	0,24	0,1	0,24	0,1
Power consumption, W:	max	min	max	min
	29	10	29	10
Start-up and Shutdown	manual			
Mass, kg, max	10			

Characteristics	Models			
	PLANAR-4DM2-12-P		PLANAR-4DM2-12-P	
Rated voltage, V	12		24	
Fuel	diesel fuel, depending on the ambient temperature			
Heating output, kW:	max	min	max	min
	3	1	3	1
Hot air flow, m ³ /h:	max	min	max	min
	120	70	120	70
Fuel consumption, l/h:	max	min	max	min
	0,37	0,12	0,37	0,12
Power consumption, W:	max	min	max	min
	46,5	10	45	9
Start-up and Shutdown	manual			
Mass, kg, max	10			